



TP01



TP01

SPECIFICATIONS



5(5)A	125/250VAC	5E4
8(8)A	125/250VAC	5E4
10(10)A	125/250VAC	5E4

FEATURES

- Usage: Power Tools
用途：電動工具
- Single and Double Pole optional
單雙極可選
- Anti-tease / Weld-safe
防撕裂/焊接安全
- Temperature Rating: 0°C~55°C
額定溫度：0°C~55°C
- Flammability Rating: UL94V-2 / Optional UL94V-0
可燃性等級：UL94V-2 / 可選 UL94V-0

ORDER INFORMATION

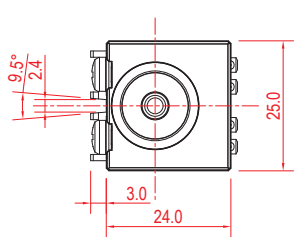
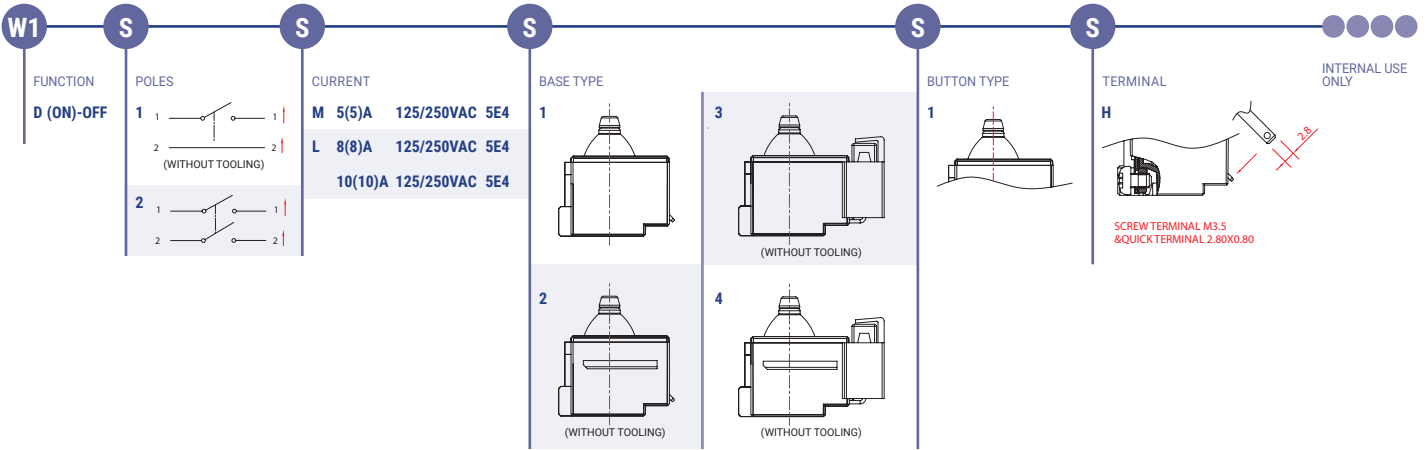

TRAVEL

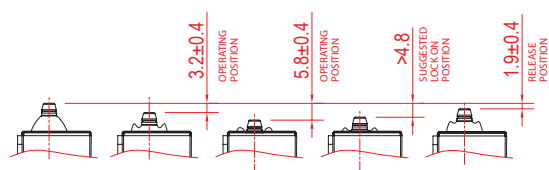

CIRCUIT DIAGRAM

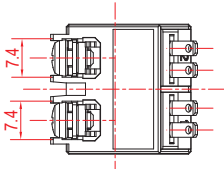
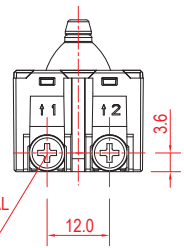
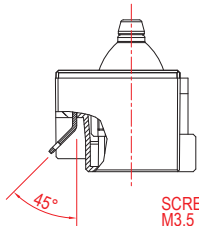
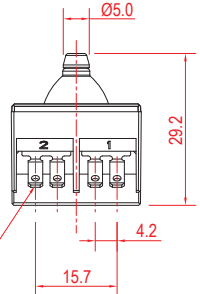
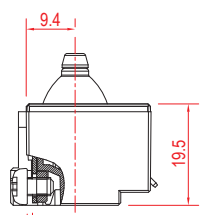
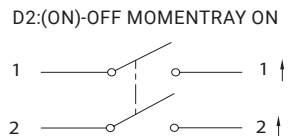

ROCKER SWITCH
ROTARY SWITCH
PUSH SWITCH
MICRO SWITCH
SLIDE SWITCH
INDICATOR LAMP
AC SOCKET
KEYBOARD SWITCH
TIMER SWITCH
POWER TOOL SWITCH